

Attaching the handgrip (Only for U.S.A.)

Attach the included handgrip by using the handgrip adaptor to make it easier to carry while jogging.

1. Insert the flange on the handgrip adaptor into the slot on the base of the unit.
2. Press the handgrip adaptor firmly against the base.
3. Adjust the buckle and fix in place.

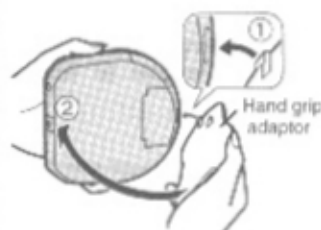

Hand grip adaptor

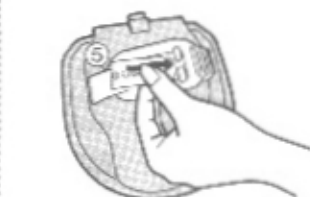

4. Fit the screw into the hole in the unit and turn in the direction indicated by the arrow to secure in place.

5. Thread the strap through the loops on the handgrip adaptor.

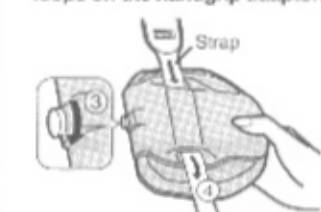

Strap

While jogging, hold the unit as shown.

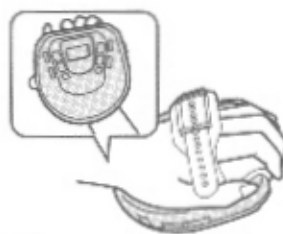
**Note**

To prevent sound from being interrupted, turn on the anti-shock function (page 3).

Dear Customer

Thank you for purchasing this product. For optimum performance and safety, please read these instructions carefully.

The model number and serial number of this product can be found on either the back or the bottom of the unit.

Please note them in the space provided below and keep for future reference.

MODEL NUMBER SL-SX279V
SERIAL NUMBER _____



COMPACT
disc
DIGITAL AUDIO

Supplied Accessories

Check the packing carton for these accessories.

| | |
|---|--|
| AC adaptor 1 pc. (RFEA420C-S or RFEA421C-W) | Only for U.S.A. Handgrip 1 pc. (RGOT0006-K) |
| For U.S.A. Stereo headphones 1 pc. (RFEV715P-KS) | Handgrip adaptor 1 pc. (RYO0308-K) |

For Canada

Stereo earphones 1 pc.
(RFEV334P-KS)

Use numbers indicated in parentheses when asking for replacement parts.
(Only for U.S.A.) To order accessories contact 1-800-332-5368 or web site (<http://www.panasonic.com>).

Before connecting, operating or adjusting this product, please read these instructions completely. Please keep this manual for future reference.



Panasonic Consumer Electronics Company, Division of
Matsushita Electric Corporation of America
One Panasonic Way Secaucus, New Jersey 07094 <http://www.panasonic.com>
Panasonic Sales Company, Division of Matsushita Electric of Puerto Rico, Inc. ("PSC")
Ave. 65 de Interferencia, Km. 9.5 San Gabriel Industrial Park, Carolina, Puerto Rico 00985
Panasonic Canada Inc.
5770 Ambler Drive, Mississauga, Ontario L4W 2T3 www.panasonic.ca
© 2000 Matsushita Electric Industrial Co., Ltd.



RQT5434-P
F0100K00
Printed in Japan

Precautions

Before using this unit, be sure to read the applicable items of the operating instructions and these safety suggestions carefully.

Afterwards keep them handy for future reference. Take special care to follow the warnings indicated on the unit itself as well as in the operating instructions.

Safety

1. **Power Source**—The unit should be connected to power supply only of the type described in the operating instructions or as marked on the unit. Use only the AC adaptor or car adaptor described in the operating instructions when recharging.
2. **Polarization**—If the unit is equipped with a polarized AC power plug (a plug having one blade wider than the other), that plug will fit into the AC outlet only one way. This is a safety feature. If you are unable to insert the plug fully into the outlet, try reversing the plug. If the plug should still fail to fit, contact your electrician to replace your obsolete outlet. Do not defeat the safety purpose of the polarized plug.
3. **Care of AC adaptor**—Take care that the cord of the AC adaptor should be routed so that they are not likely to be walked on or pinched by items placed upon or against them. Never take hold of the AC adaptor if your hand is wet, and always grasp the plug body when connecting or disconnecting it.
4. **Nonuse Periods**—When not in use, be sure to disconnect the AC adaptor from the AC power outlet.
5. **Batteries**—If the set is not used for a long period of time or is used only from an AC power source, remove all the batteries to prevent potential damage due to possible battery leakage. Do not mix batteries (old and new) or different types of batteries.

Installation**Environment**

1. **Water and Moisture**—Do not use this unit near water—for example, near a bathtub, washbowl, swimming pool, or the like. Damp basements should also be avoided.
2. **Condensation**—Moisture may form on the lens in the following conditions.
 - immediately after a heater has been turned on.
 - in a steamy or very humid room.
 - when the unit is suddenly moved from a cold environment to a warm one. If moisture forms inside this unit, it may not operate properly. To correct this problem wait about one hour for the moisture to evaporate.
3. **Heat**—Never use or place this unit near a heat source. Do not leave it in an automobile exposed to direct sunlight for a long time with the doors and windows closed as this may deform the cabinet.

Placement

1. **Foreign Material**—Care should be taken so that objects do not fall into and liquids are not spilled into the unit. Do not subject this unit to excessive smoke, dust, mechanical vibration, or shock.
2. **Magnetism**—The unit should be situated away from equipment or devices that generate strong magnetic fields.
3. **Stacking**—Do not place any objects, on top of the unit.

Maintenance

(See page 5 for details.)

Clean the cabinet, panel and controls with a soft cloth lightly moistened with mild detergent solution. Do not use any type of abrasive pad, scouring powder or solvent such as alcohol or benzene.

Service

1. **Damage Requiring Service**—The unit should be serviced by qualified service personnel when:
 - (a) The AC adaptor is damaged; or
 - (b) Objects have fallen or liquid has been spilled into the unit; or
 - (c) The unit has been exposed to rain; or
 - (d) The unit does not appear to operate normally or exhibits a marked change in performance; or
 - (e) The unit has been dropped, or the enclosure damaged.
2. **Servicing**—The user should not attempt to service the unit beyond that described in the operating instructions. All other servicing should be referred to an authorized service personnel.
For the address of an authorized servicenter:
In the U.S.A., call 1-800-211-7262, e-mail consumerproducts@panasonic.com, or visit www.panasonic.com
In Canada, call 905-624-5505 or visit www.panasonic.ca



This manual was printed with soy based ink.

Power Supply Preparations

Refer to the specifications (page 8) for information on operating times when using rechargeable batteries or dry-cell batteries.

Using the AC adaptor

Connect the AC adaptor supplied.

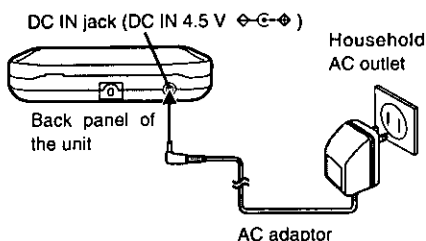

Note

Turn the unit off before connecting or disconnecting the AC adaptor.

Conserving power

The AC adaptor consumes 2.0 W when the unit is turned off with [■, OPR OFF]. To save power when the unit is not to be used for a long time, unplug the AC adaptor from the household AC outlet. Reprogram tracks if necessary before use.

Using the rechargeable batteries (not included)

Obtain the optional rechargeable batteries (page 8). Make sure to recharge the batteries before using them. The unit cannot be used to charge rechargeable batteries other than those specifically designed for it.

- Optional batteries (P-3GAVA/2B)

Recharging procedure

1 Insert the special rechargeable batteries into the unit.

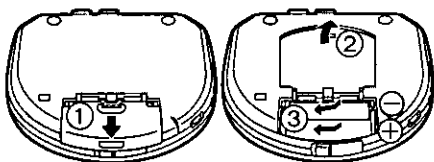

2 Connect the AC adaptor.

(Refer to "Using the AC adaptor" for connection instructions.)

Recharging starts and the "Ⓢ" charging indicator flashes on and off on the unit's display.

When the rechargeable batteries are fully recharged the charging indicator disappears.

3 When recharging is complete, unplug the AC adaptor from the household AC outlet and the DC IN jack.

Note

- Rechargeable batteries have a service life of approximately 300 charge-discharge cycles. If the operating time on one full charge becomes noticeably shorter than it used to be, the battery has reached the end of its service life and should be replaced.
- Recharging may only be performed when the unit is powered off. (It is not possible to recharge the batteries while playing a CD.)
- The AC adaptor and rechargeable batteries may become warm while recharging is in progress. This is not a malfunction.
- Turn the unit off before replacing the rechargeable batteries.

If the battery lid comes loose

Slide the lid back into place horizontally.

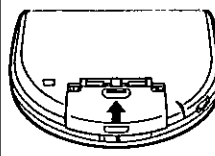

Removing batteries

Push up on the battery in the direction indicated by the arrow. Then lift it out.

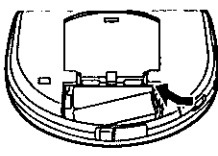

Using the car adaptor (not included)

Be sure to obtain the car adaptor (SH-CDC9), available as an optional accessory.

CAUTION:

Use only car adaptor, Model: SH-CDC9 manufactured by Matsushita Electric Industrial Co., Ltd.

The car adaptor can be used to recharge the unit's batteries while in the car.

Using dry-cell batteries (not included)

After disconnecting the AC adaptor, insert two "AA" (LR6) alkaline batteries.

The procedure for inserting and removing dry-cell batteries is identical to that for rechargeable batteries.

Note

The dry cell batteries should be changed when the unit is off.

When the battery indicator flashes

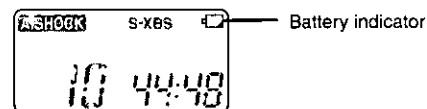

Power is cut off a short while later. Recharge the rechargeable batteries or replace the dry cell batteries with new ones.

Note

- How long the unit continues to operate after the battery indicator starts flashing depends on the type of batteries and on whether you are using the unit to play CDs or the radio.
- The battery indicator may not flash if rechargeable batteries, other than those designated by Panasonic, are used.

If the unit malfunctions or freezes during use, disconnect the power sources (the AC adaptor or batteries). Re-connect the power source and continue operation.

HOLD Function

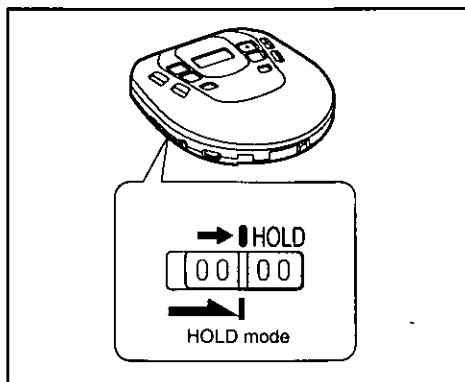

This function causes the unit to ignore short, accidental button presses. (The disc lid can still be opened and closed.)

HOLD function prevents the following:

- Powering on the unit accidentally (which can cause the batteries to run down).
- Play being cut off unexpectedly in the middle of a selection.

To use HOLD function

Set [HOLD] to the HOLD position.

"h o l d" Indication

When the unit is in HOLD status, pressing any operation button causes the indication "h o l d" to appear on the display.

When the unit is powered off:

The "h o l d" indication appears only when [▶||] or [RADIO/BAND] is pressed.

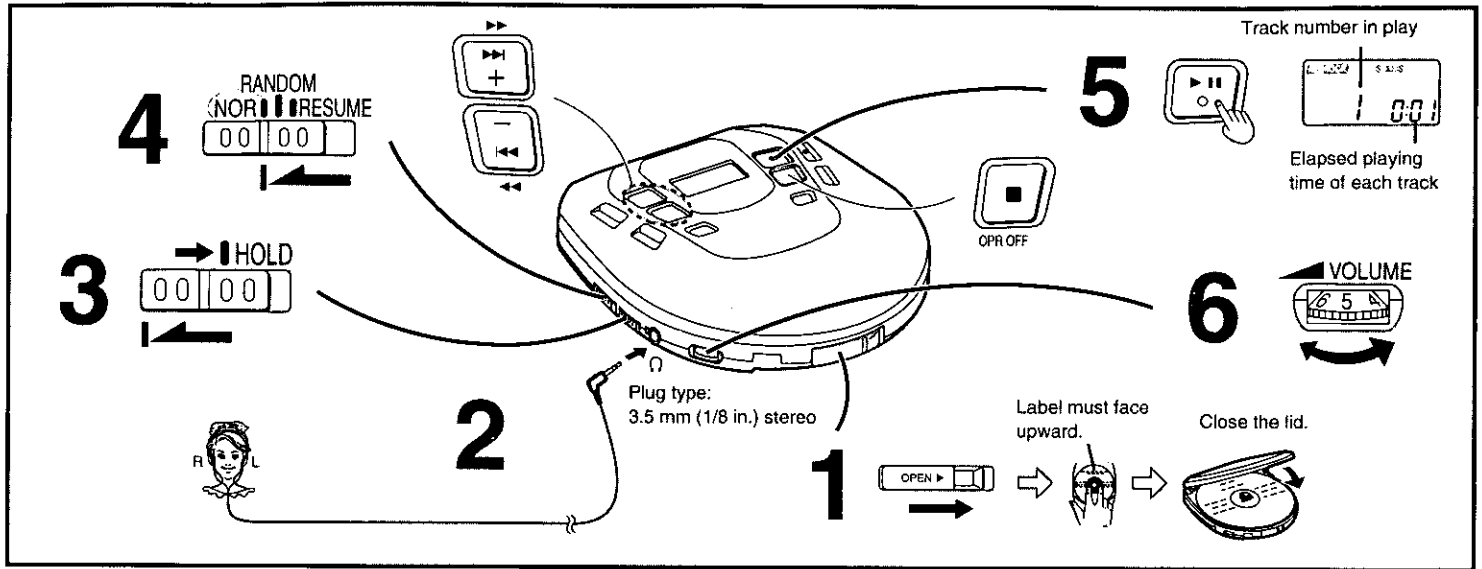

- 1** Slide [OPEN] to open the lid, and insert the disc.
- 2** Connect the stereo headphones /stereo earphones to [Ω]. (Plug in firmly.)
- 3** Release HOLD.
- 4** Set Play mode selector to [NOR].
- 5** Press [▶||] to start play. (Play stops automatically when all the tracks have been played.)
- 6** Adjust the volume. If the unit has been connected to the car audio system, adjust the volume level between 4 and 6 on the unit, then adjust the volume level on the system.

■ To pause play

Press during play. (Press again to restart play.)

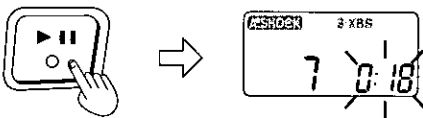

■ To stop play Stop mode

Press during play.

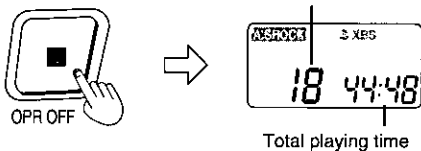

■ To turn off the unit Off mode

Press during stop mode.

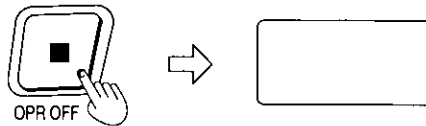

■ Skip / Search function

Skip function : Press during play.

Search function : Press and hold during play.

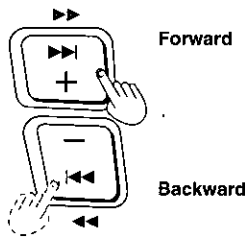

- During program play (page 4), these buttons are used to skip forward or back through the programmed sequence of tracks.
- During random play (page 4), the skip buttons cannot be used to skip back to tracks that were played previously in the random sequence.
- During program play, random play or 1-track repeat play (page 4), search operation is limited to the current track only.

For your reference:

“no disc” indication

This indication appears for about 30 seconds if [▶||] is pressed when no disc is loaded in the unit or if the disc is not properly secured.

“OPEN” indication

This indication appears for about 10 minutes when the cover is opened. (However, the indication does not appear when the unit is powered off.)

Auto power off function

If the unit is left in stop or paused status for approximately 10 minutes, the unit powers itself off automatically in order to prevent the batteries from running down. (If no disc is loaded in the unit it powers itself off in 30 seconds.)

Removing discs

- 1** Press [■, OPR OFF] to stop play and disc rotation.
- 2** Slide [OPEN] to open the lid.
- 3** Press [PUSH] to release the disc.

Do not stop the disc by hand or try to remove it before it stops rotating. This can damage CDs.

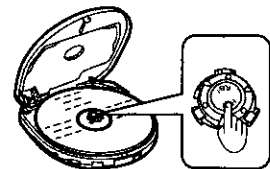

Note

Never insert foreign objects into the unit body.

Anti-Shock Function

The letters such as **A** in the various illustrations refer to the descriptions in the “Location of Controls” section. (See page 4.)

Anti-shock works by reading audio data and storing it in memory (up to 40 seconds worth). The unit then fills in interruptions caused by bumps and vibrations with data from the memory. This unit also incorporates a powerful anti-shock mechanism that prevents skipping caused when play speed is changed by swinging of the unit.

Press during play or stop mode.



The following indicator appears on the display.

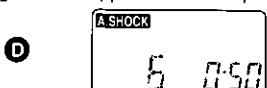

When bumps continue repeatedly

The message “SORRY” appears on the display and sound is interrupted.



To cancel the anti-shock function

Press [A.SHOCK, FM MODE MONO/ST] again.

Note

- The anti-shock setting can be changed during play, but this may cause a slight interruption in the sound because the disc’s rotation speed changes.
- During anti-shock operation, the disc rotates at a higher rate than usual to collect extra audio data. This could result in a slight increase in disc rotation noise.

Listening to sound with the unit connected to an audio system

The anti-shock function uses digital signal compression technology. It is recommended that the anti-shock function be canceled if the unit is connected to a home audio system.

The letters such as **A** in the various illustrations refer to the descriptions in the "Location of Controls" section.

Skip play

The disc plays from the specified track through to the end, then play stops automatically.

Preparation: Put unit in stop mode.



2 Select the desired track.



Program play

Up to 24 tracks can be entered in the programmed sequence.

Preparation: Put unit in stop mode.



2 Select the desired track.



3 Register in sequence.

(The indication "M" and the programmed sequence appear on the display.)



4 Repeat steps 2 and 3 to program all the desired tracks.



■ To program the same track in the sequence more than once

After step 3, press [MEMORY/RECALL] the desired number of times.

■ If "F" is displayed

No more tracks can be programmed.

■ To confirm the contents of the program

Press [MEMORY/RECALL] while the disc is playing. (The numbers of the programmed tracks appear on the display in sequence.)

■ To delete the entire programmed sequence

Press [OPR OFF].

Random play



Release



For your reference:

- It is also possible to press [▶▶▶ +] while the unit is in stop mode to change the first track to be played. (All tracks are played eventually, regardless of which is played first.)
- Program play is not possible in the random mode.

Resume play

This function allows you to listen from the beginning of the track where play stopped because the unit was powered off (or switched to stop mode). It is useful when listening to CDs in the car, etc.



Release



For your reference:

- If [NOR, RANDOM, RESUME] is put in the [RESUME] position, the all-track repeat function will be activated automatically as soon as the unit is powered on.
- If power is cut off near the end of a track (off mode), playback may resume from the beginning of the next track.
- If the unit is powered off while a disc was playing and then a new disc is inserted, play will begin from the middle of the new disc because the unit remembers the position where play stopped on the previous disc.

Repeat function

Press during play or stop mode.



Each time the button is pressed;

"1" → "ALL" → " " (Cancel)

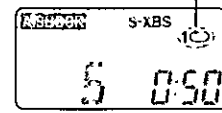

1 (1-track repeat)

One track is repeated.

ALL (All-track repeat)

All the tracks on the disc are repeated.

For your reference:

If "ALL" is selected during program play, only the tracks in the program are repeated. ("ALL" is not displayed.)

Changing the sound quality

Press during play or stop mode.



Each time the button is pressed;

"S-XBS" → " " (Cancel)

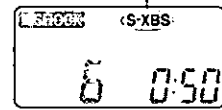

S-XBS:

Select to boost the low-range response.

Location of Controls

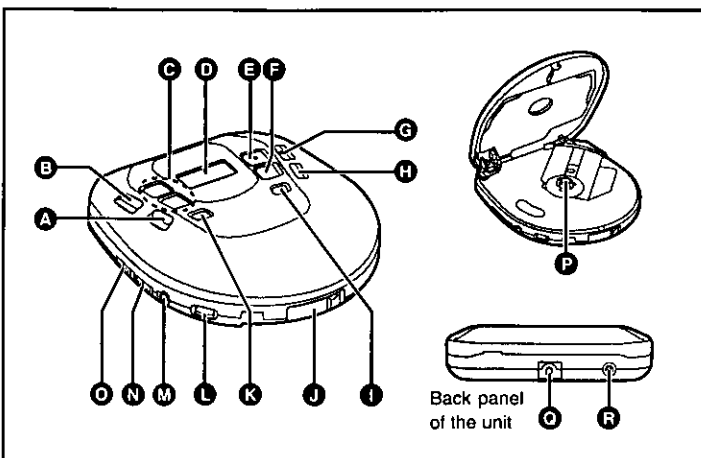

- A** Memory/recall button (MEMORY/RECALL)
- B** Tuning mode select button (TUNING MODE)
- C** Tuning/skip/search buttons (▶▶▶ +, ◀◀◀ -)
- D** Display
- E** Play/pause button (▶||)
- F** Stop/operation off button (■, OPR OFF)
- G** Tuner on/band select button (RADIO/BAND)
- H** S-XBS button (S-XBS)
- I** Repeat, sensitivity control button (◁, FM RECEPT = CITY/NOR)

- J** Open switch (OPEN)
- K** Anti-shock, monaural/stereo button (A. SHOCK, FM MODE MONO/ST)
- L** Headphone volume control (VOLUME)
- M** Headphone jack (◯)
- N** Hold switch (HOLD)
- O** Play mode selector (NOR, RANDOM, RESUME)
- P** CD release button (PUSH)
- Q** Hole for car mounting base/hand grip adaptor
- R** DC IN jack (DC IN 4.5 V ⚡)

Using the Unit with Optional Accessories

Using the unit with an audio system

Using the stereo connection cable (not included), you can listen to CDs on your audio system.

- Turn off the amplifier power and connect the cable.
- Do not connect the cable to the PHONO jacks on the amplifier.
- Obtain the optional connecting cable if the amplifier comes with mini-phone jacks.
- Adjust the volume on the amplifier.
- Set the unit's VOLUME between 4 and 6.

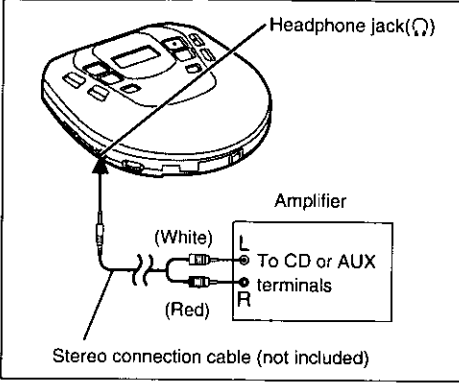

Using the unit with a car audio system

Items to be purchased

For connection to the car audio system:

- Car stereo cassette adaptor (SH-CDM10A)

Connect the car stereo cassette adaptor to the unit's headphone jack. (When doing this, keep the unit's VOLUME at a setting between 4 and 6.)

For securing the unit and connecting the power supply:

- Car adaptor (SH-CDC9)
- Car mounting kit (SH-CDF20)

Note

- It may not be possible to use the unit with some types of car stereo owing to restrictions imposed by the construction of the car stereo cassette adaptor.
- Move the unit away from the car adaptor if noise interferes with the radio.

For further details, refer to the instructions of the part concerned.

Note when using the car mounting kit (SH-CDF20)

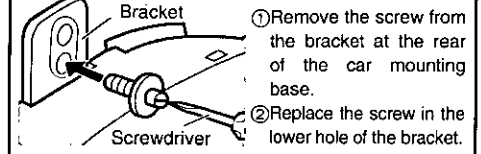

Maintaining the Lens

Open the lid and clean the lens as shown in the figure. Use a cotton swab to gently wipe off any finger-prints. Recommended product: Lens cleaner kit (SZZP1038C)

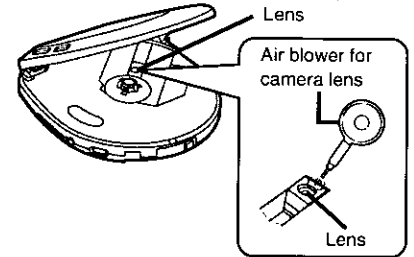

Panasonic Consumer Electronics Company, Division of Matsushita Electric Corporation of America
One Panasonic Way,
Secaucus, New Jersey 07094

ONLY FOR U.S.A. Panasonic Audio Products Limited Warranty

Panasonic Sales Company, Division of Matsushita Electric Corporation of Puerto Rico, Inc.
Ave. 65 de Infantería, Km. 9.5
San Gabriel Industrial Park,
Carolina, Puerto Rico 00985

Panasonic Consumer Electronics Company or Panasonic Sales Company (collectively referred to as "the warrantor") will repair this product with new or refurbished parts in the event of a defect in materials or workmanship, free of charge, in the U.S.A. or Puerto Rico as follows (all time periods start from the date of original purchase):

COMPACT DISC PLAYERS, RADIOS, VIDEO CD PLAYERS, RADIO CASSETTE PLAYERS/RECORDERS (with and without CD Players), CASSETTE RECORDERS, MICROCASSETTE RECORDERS/TRANSCRIBERS AND IC RECORDERS—labor and parts for one (1) year.

ACCESSORIES—HEADPHONES, CARTRIDGES, MICROPHONES, ADAPTERS—labor and parts for ninety (90) days.

BATTERIES—(when applicable)—New rechargeable batteries in exchange for defective rechargeable batteries for ten (10) days. Non-rechargeable batteries are not warranted.

RECHARGEABLE BATTERY PACKS—(when applicable)—New rechargeable battery packs in exchange for defective rechargeable battery packs for ninety (90) days. Non-rechargeable battery packs are not warranted.

Carry-in or mail-in service in the U.S.A. can be obtained during the warranty period by contacting a Panasonic Services Company (PASC) Factory Servicenter listed in the Servicenter Directory. Or call toll free, 1-800-211-7262 to locate a PASC authorized Servicenter. Carry-in or mail-in service in Puerto Rico can be obtained during the warranty period by calling the Panasonic Sales Company telephone number listed in the Servicenter Directory.

This warranty is extended only to the original purchaser. A purchase receipt or other proof of date of original purchase will be required before warranty service is rendered.

This warranty only covers failures due to defects in materials and workmanship

which occur during normal use and does not cover normal wear to the stylus (when applicable) or a dealer installed cartridge or stylus. The warranty does not cover damages which occur in shipment or failures which are caused by products not supplied by the warrantor, or failures which result from accident, misuse, abuse, neglect, mishandling, faulty installation, misapplication, set-up adjustments, maladjustment of consumer controls, improper operation or maintenance, improper antenna, inadequate signal reception or pick-up, alteration, modification, power line surge, improper voltage supply, lightning damage, commercial use, such as; hotel, office, restaurant, or other business or rental use of the product, or service by anyone other than a PASC Factory Servicenter or a PASC authorized Servicenter, or damage that is attributable to acts of God.

LIMITS AND EXCLUSIONS

There are no express warranties except as listed above.

THE WARRANTOR SHALL NOT BE LIABLE FOR INCIDENTAL OR CONSEQUENTIAL DAMAGES RESULTING FROM THE USE OF THIS PRODUCT, OR ARISING OUT OF ANY BREACH OF THIS WARRANTY, INCLUDING WITHOUT LIMITATION, DAMAGE TO TAPES, RECORDS OR DISCS. ALL EXPRESS AND IMPLIED WARRANTIES, INCLUDING THE WARRANTIES OF MERCHANTABILITY, AND FITNESS FOR A PARTICULAR PURPOSE, ARE LIMITED TO THE APPLICABLE WARRANTY PERIOD SET FORTH ABOVE. Some states do not allow the exclusion or limitation of incidental or consequential damages, or limitations on how long an implied warranty lasts, so the above exclusions or limitations may not apply to you.

This warranty gives you specific legal rights and you may also have other rights which vary from state to state.

If a problem with this product develops during or after the warranty period, you may contact your dealer or Servicenter. If the problem is not handled to your satisfaction, then write to the Panasonic Consumer Call Center at the company address above or call toll free 1-800-211-7262.

If you ship the product

Carefully pack and send it prepaid, adequately insured and preferably in the original carton. Attach a postage-affixed letter, detailing the complaint, to the outside of the carton.

Do NOT send the product to the Executive or Regional Sales offices. They are NOT equipped to make repairs.

Customer's Record

Model No. _____

Serial No. _____
or _____

Code No. _____

Date of Purchase _____

Dealer's Name _____

Dealer's Address _____

Listening to the Radio

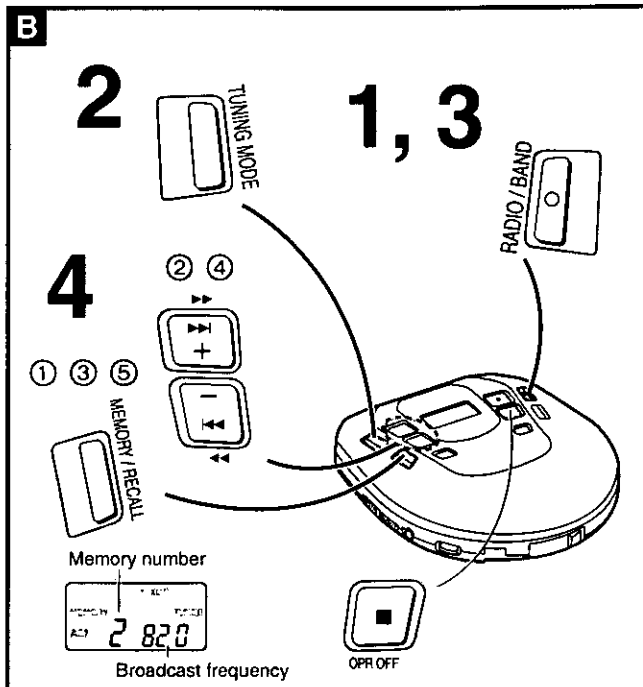
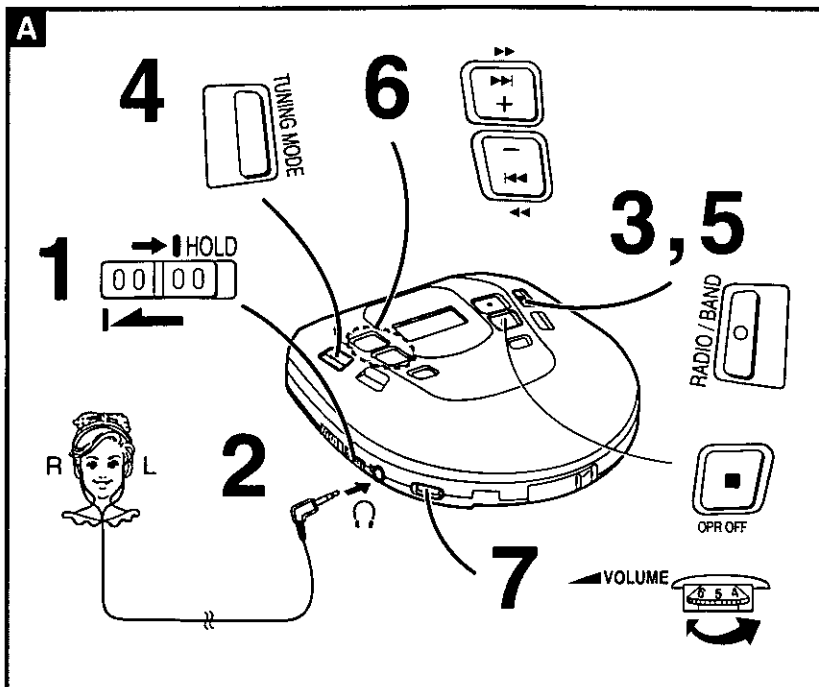

Listening Operation

You can tune directly to the station in **Free Mode** by finding the station's frequency, or you can store the station in **Memory Mode** to make tuning simpler. You can choose these modes with [TUNING MODE].

A Free Mode

- 1 Release HOLD.
- 2 Connect the stereo headphones/stereo earphones to [Ω]. (Plug in firmly.)
- 3 Press [RADIO/BAND] to turn on the radio.
- 4 Press [TUNING MODE] to set to Free Mode.

The display in Free mode is as follows.

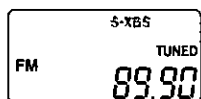

- 5 Press [RADIO/BAND] to change the band.
Each time the button is pressed;
FM ↔ AM
- 6 Press [▶▶ ▶▶ +, ◀◀ ◀◀ -] to select the frequency of the station.
+ : increases frequency
- : decreases frequency

For your reference:

- Press for over 1.5 seconds to make the frequency change rapidly.
- "TUNED" is displayed when a station is tuned.

- 7 Adjust the volume.

■ To turn off the radio

Press [■, OPR OFF].

B Memory Mode

■ Putting stations into the channels

Frequencies of up to 30 stations can be stored; 20 FM and 10 AM.

Preparation:

- Release HOLD.
- Connect the headphones/earphones as they act as an FM antenna.

- 1 Press [RADIO/BAND] to turn on the radio.
- 2 Press [TUNING MODE] to set to Memory Mode.

The display in Memory Mode is as follows.

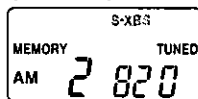

- 3 Press [RADIO/BAND] to change the band.
Each time the button is pressed;
FM ↔ AM
- 4 Put stations into the channels of your choice.

① Press [MEMORY/RECALL].

The frequency number flashes.

② Within 10 seconds

Press [▶▶ ▶▶ +, ◀◀ ◀◀ -] to select the frequency to be memorized.

③ Within 10 seconds

Press [MEMORY/RECALL].

The memory number flashes.

④ Within 10 seconds

Press [▶▶ ▶▶ +, ◀◀ ◀◀ -] to select the memory number to store the frequency.

FM station: up to 20

AM station: up to 10

⑤ Within 10 seconds

Press [MEMORY/RECALL] to confirm the memory setting.

- Press [▶▶ ▶▶ +, ◀◀ ◀◀ -] for over 1.5 seconds to make the frequency or memory number change in succession.
- "TUNED" is displayed when a station is tuned.

■ Recalling preset stations

Preparation:

- Release HOLD.
- Connect the headphones/earphones to [Ω].
- Perform steps 1-3 of "Putting stations into the channels".

- 1 Press [▶▶ ▶▶ +, ◀◀ ◀◀ -] to select the desired station.

Memory number and broadcast frequency changes.

- 2 Adjust the volume.

■ To erase unnecessary preset stations from the memory

Preparation:

Perform step 1-3 of "Putting stations into the channels".

- 1 Press [▶▶ ▶▶ +, ◀◀ ◀◀ -] to select the memory number to be erased.

- 2 ① Press [MEMORY/RECALL].

The frequency number flashes.

② Within 10 seconds

Press and hold [MEMORY/RECALL] until "-- --" flashes.

③ Within 10 seconds

Press [MEMORY/RECALL] to erase the memory number.

The memory number of the next preset station appears on the display.

■ To put a station into a channel you erased

Repeat the procedure described at left.

■ To turn off the radio

Press [■, OPR OFF].

Listening to the Radio

The letters such as **A** in the various illustrations refer to the descriptions in the "Location of Controls" section. (See page 4.)

To obtain good reception

AM

Try various directions to obtain optimum reception.

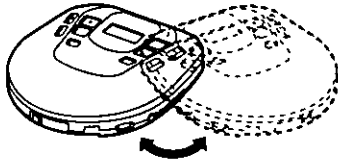

Note

The AM antenna is located in the lid of the unit so noise may increase if the unit is held. This is not malfunction.

FM

The headphone/earphone cord is also the FM antenna, so extend it rather than leaving it coiled.

How to receive an FM broadcast clearly

Press for more than 1.5 seconds during FM reception.

Each time the button is pressed;



"CITY" ← " " (normal)

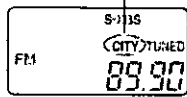

Leave off under normal conditions. Set to "CITY" if reception is poor or if there is interference from another station.

To select stereo or monaural FM

Press during FM reception.

Each time the button is pressed;



"MONO" ← " " (stereo)

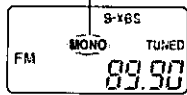

When there is noise during FM reception

Select "MONO".

Sound becomes monaural, but noise is reduced.

Concerning Compact Discs

Only compact discs bearing this mark can be used with this unit.

However, continued use of irregular shaped CDs can damage the unit.



How to remove a disc from its case

How to store the disc in its case

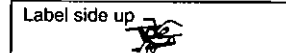
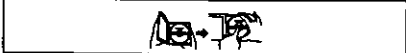

How to hold a disc



If the surface is dirty

Wipe it with a damp cloth and then wipe dry. Wipe from the center toward the outer circumference.

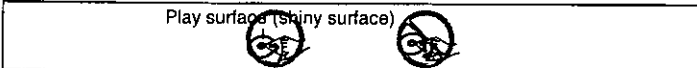

Handling precautions

• If you are taking the CD from a cold to a warm environment, moisture may form on the CD. Wipe this off with a soft, dry, lint-free cloth before using the CD.

• Do not write on the label side with a ball-point pen or other writing instrument.

• Do not use record cleaning sprays, benzine, thinner, static electricity prevention liquids or any other solvent.

• Do not attach labels or stickers to CDs. (Do not use CDs with exposed adhesive from tape or left over peeled off stickers.)

• Do not use scratch-proof protectors or covers other than those specified for use with this system.

Storage precautions

Be sure to store CDs in their cases to protect them from dust, scratches, and warping.

Do not place or store CDs in the following places.

- Locations exposed to direct sunlight
- Humid or dusty locations
- Locations directly exposed to a heat vent or heating appliance
- In the glove compartment or on the rear deck of an automobile

The product you have purchased is powered by a nickel-cadmium battery which is recyclable. Please call 1-800-8-BATTERY for information on how to recycle this battery.



When using overseas

Change the frequency step according to the area.

Preparation: Press [RADIO/BAND] to switch on the power.

1 Press for more than 5 seconds to display the step.



2 Within 10 seconds

Press to select the step.

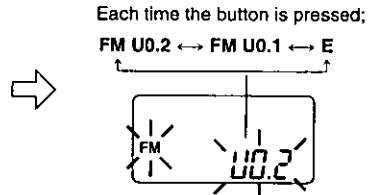
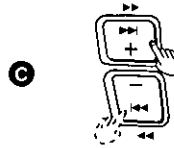

FM U0.2 (original setting) : FM 0.2 MHz, AM 10 kHz

FM U0.1 : FM 0.1 MHz, AM 10 kHz

E : FM 0.05 MHz, AM 9 kHz

3 Within 10 seconds

Press and hold until the frequency is displayed to confirm the step.

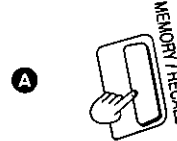

To return to the previous frequency step

Repeat the above procedure.

Note

Converting the allocation erases the stations previously stored in memory.

Changing the sound quality

The operation is the same as when playing CDs.

(See page 4.)

CAUTION!

THIS PRODUCT UTILIZES A LASER. USE OF CONTROLS OR ADJUSTMENTS OR PERFORMANCE OF PROCEDURES OTHER THAN THOSE SPECIFIED HEREIN MAY RESULT IN HAZARDOUS RADIATION EXPOSURE. DO NOT OPEN COVERS AND DO NOT REPAIR YOURSELF. REFER SERVICING TO QUALIFIED PERSONNEL.

WARNING:

TO REDUCE THE RISK OF FIRE, ELECTRIC SHOCK OR PRODUCT DAMAGE, DO NOT EXPOSE THIS APPLIANCE TO RAIN, SPLASHING, DRIPPING OR MOISTURE.

THE FOLLOWING APPLIES ONLY IN THE U.S.A.:

CAUTION:

This equipment has been tested and found to comply with the limits for a Class B digital device, pursuant to Part 15 of the FCC Rules.

These limits are designed to provide reasonable protection against harmful interference in a residential installation. This equipment generates, uses and can radiate radio frequency energy and, if not installed and used in accordance with the instructions, may cause harmful interference to radio communications. However, there is no guarantee that interference will not occur in a particular installation. If this equipment does cause harmful interference to radio or television reception, which can be determined by turning the equipment off and on, the user is encouraged to try to correct the interference by one of the following measures:

- Reorient or relocate the receiving antenna.
- Increase the separation between the equipment and receiver.
- Connect the equipment into an outlet on a circuit different from that to which the receiver is connected.
- Consult the dealer or an experienced radio/TV technician for help.

Any unauthorized changes or modifications to this equipment would void the user's authority to operate this device.

This device complies with Part 15 of the FCC Rules. Operation is subject to the following two conditions: (1) This device may not cause harmful interference, and (2) this device must accept any interference received, including interference that may cause undesired operation.

Specifications

CD SECTION

■ **Audio (Anti-shock off)**
 No. of channels: 2 (left and right, stereo)
 DA converter: 1 bit, MASH
 Headphone output level: Max. 9 mW+9 mW/16 Ω (adjustable)
 ■ **Pickup**
 Light source: Semiconductor laser
 Wavelength: 780 nm

Dimensions (W×H×D): 128×29.8×131.5 mm (5¹/₁₆"×1¹/₄"×5³/₁₆")
 Mass: 266 g (9.4 oz.) (with batteries)
 218 g (7.7 oz.) (without batteries)
 Operational temperature: 0 °C–40 °C (32 °F–104 °F)
 Rechargeable temperature: 5 °C–40 °C (41 °F–104 °F)

RADIO SECTION

■ **Frequency**
 Radio frequency: FM; 87.9–107.9 MHz (0.2 MHz steps)
 87.5–108.0 MHz (0.1 MHz/0.05 MHz steps)
 AM; 520–1710 kHz (10 kHz steps)
 522–1629 kHz (9 kHz steps)

Play time: [Approximate operating time in hours (in hold mode with S-XBS canceled, at 25 °C (77 °F) on a flat, stable surface)]

| Batteries used | CD (Anti-shock off/on) | RADIO |
|--|------------------------|-------|
| 2 alkaline batteries | 18 / 23 | 62 |
| Optional rechargeable batteries (P-3GAVA/2B) | 8 / 10 | 25 |

The play time may be less depending on the operating conditions.
 Recharging time: About 5 hours

Power consumption in standby mode: 2.0 W

Note:
 Specifications are subject to change without notice.
 Mass and dimensions are approximate.

GENERAL

Power supply: DC 4.5 V
 Power consumption:

| Power source | CD (Anti shock off/on) /RADIO |
|--------------|-------------------------------|
| AC adaptor | 2.4 W/2.6 W/1.9 W |

When recharging: Approx. 3.2 W

Troubleshooting Guide

Before requesting service for this unit, check the chart below for a possible cause of the problem you are experiencing. Some simple checks or a minor adjustment on your part may eliminate the problem and restore proper operation. If you are in doubt about some of the check points, or if the remedies indicated in the chart do not solve the problem, refer to the directory of Authorized Service Centers (enclosed with this unit) to locate a convenient service center, or consult your dealer for instructions.

For detailed instructions, contact an authorized servicenter in the U.S.A. and Panasonic Canada Inc. Customer Care Centre in Canada.
In the U.S.A., call 1-800-211-7262, e-mail consumerproducts@panasonic.com, or visit www.panasonic.com
In Canada, call 905-624-5505 or visit www.panasonic.ca

| Problem | Check this |
|---|--|
| Cannot close cover. | Is the disc properly secured in place? |
| Cannot play discs. | <ul style="list-style-type: none"> Is the unit in HOLD status? Is the disc properly secured in place? Is there condensation on the lens? (Wait for about an hour and then try again.) |
| Cannot remove disc. | Did you press [PUSH] to release the disc? |
| Tracks on disc do not play in order, starting with the first track. | Is [NOR, RANDOM, RESUME] in [NOR] position? |
| Cannot hear music—too noisy. | <ul style="list-style-type: none"> Is the headphones/earphones plug inserted all the way? Is the plug dirty? (Wipe away dirt on plug.) Separate the unit from mobile phones. |
| TV picture is distorted. Radio reception is noisy. | Are you using the unit body too near a TV or tuner? (If the TV or tuner is connected to a simple indoor antenna, connect it to an outdoor antenna.) |
| No reception. The FM frequency range is different. | Has the frequency step been set for your area? |

Cautions

Listening caution



Do not play your headphones or earphones at a high volume. Hearing experts advise against continuous extended play.

If you experience a ringing in your ears, reduce volume or discontinue use.

Do not use while operating a motorized vehicle. It may create a traffic hazard and is illegal in many areas.

You should use extreme caution or temporarily discontinue use in potentially hazardous situations.

Even if your headphones or earphones are the open-air type designed to let you hear outside sounds, don't turn up the volume so high that you can't hear what's around you.

Sound can be deceiving. Over time your hearing "comfort level" adapts to higher volumes of sound. So what sounds "normal" can actually be loud and harmful to your hearing.

Guard against this by setting your equipment at a safe level BEFORE your hearing adapts.

To establish a safe level:

- Start your volume control at a low setting.
- Slowly increase the sound until you can hear it comfortably and clearly, and without distortion.

Once you have established a comfortable sound level:

- Set the dial and leave it there.

When driving a car

In the interest of traffic safety, do not operate the unit while driving.

Selection and care of rechargeable /dry cell batteries

■ Selection

As a safety precaution, the portable CD players made by Panasonic are constructed so it is impossible to recharge ordinary batteries.

Only batteries especially designed for this unit can be recharged.

Special rechargeable Ni-Cd batteries:
P-3GAVA/2B (set of 2)

For details, check with your dealer.

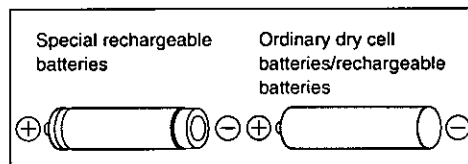

- If rechargeable battery play time is short after recharging, the batteries have reached the end of their service life. Replace them with the recommended replacements.
- Play time may be shorter than usual after recharging batteries for the first time or after they have been unused for a long time. Repeatedly recharge and discharge the batteries if this occurs to restore them to normal.

■ Care

To prevent battery damage, electrolyte leakage and short-circuiting, heed the following points.

- Do not peel off the covering on batteries and do not use if the covering has been peeled off.
- Align the poles ⊕ and ⊖ correctly when inserting the batteries.
- Do not mix different types or makes of batteries or old and new batteries.
- Remove the batteries if you do not intend to use the unit for a long time.
- Do not throw into fire, short-circuit, disassemble, or subject to excessive heat.
- Do not attempt to recharge dry cell batteries.
- Do not allow metal objects to touch the battery terminals as this may cause short-circuiting which is dangerous.
- When carrying batteries in a pocket or bag, ensure no metal objects such as necklaces are placed together with them. Contact with metal may cause short-circuiting which can cause a fire. For safety, carry the rechargeable batteries in the battery carrying case.

Product Service

Do not attempt to remove the cover(s) or repair the unit yourself. Refer servicing to qualified personnel only.

Product information

For product service, product information or assistance with product operation, refer to the servicenter directory.

User memo:

DATE OF PURCHASE _____
 DEALER NAME _____
 DEALER ADDRESS _____
 TELEPHONE NUMBER _____